



A DOMAIN SPECIFIC APPROACH TO HETEROGENEOUS PARALLELISM

Hassan Chafi, Arvind Sujeeth, Kevin Brown, HyoukJoong Lee,
Anand Atreya, Kunle Olukotun

Stanford University
Pervasive Parallelism Laboratory (PPL)

Era of Power Limited Computing

■ Mobile

- Battery operated
- Passively cooled

■ Data center

- Energy costs
- Infrastructure costs



Computing System Power

$$Power = Energy_{op} \times \frac{Ops}{second}$$

=



Heterogeneous Hardware

- Heterogeneous HW for energy efficiency
 - Multi-core, ILP, threads, data-parallel engines, custom engines
- H.264 encode study

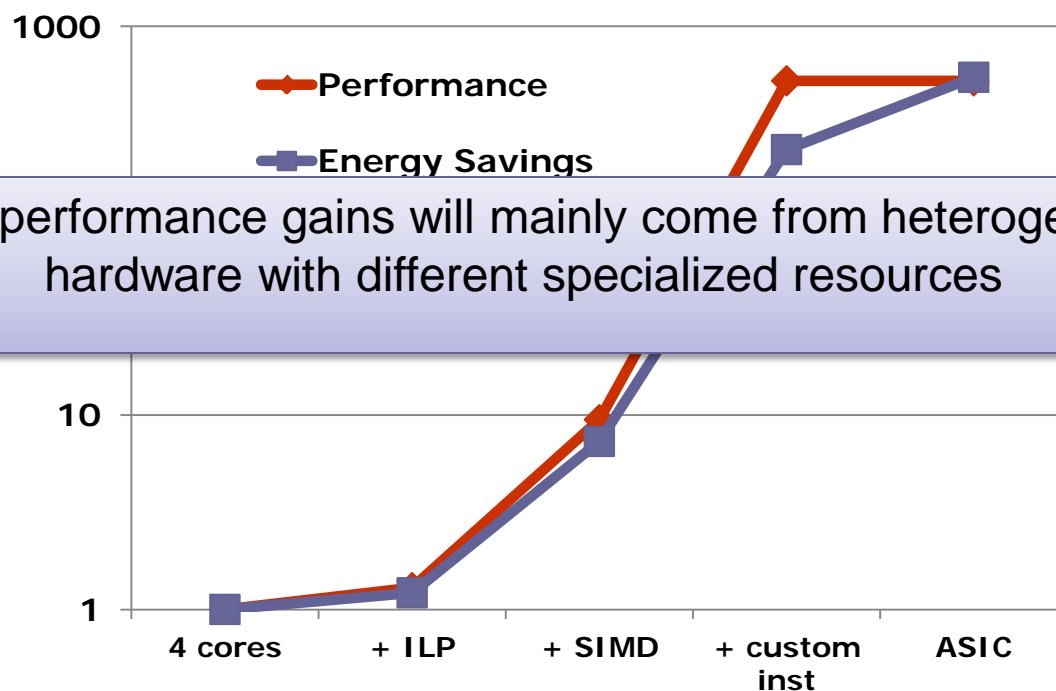

Future performance gains will mainly come from heterogeneous hardware with different specialized resources

Heterogeneous Parallel Architectures

Driven by energy efficiency

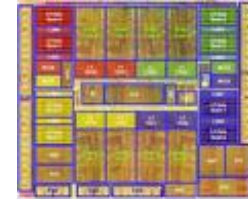

Sun
T2

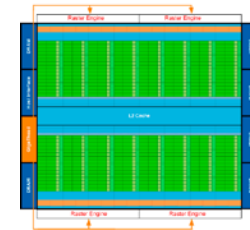

Nvidia
Fermi

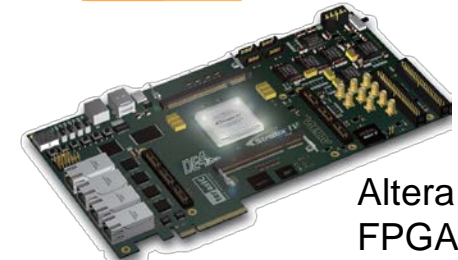

Altera
FPGA

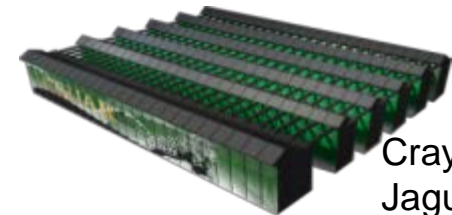

Cray
Jaguar

Heterogeneous Parallel Programming

Pthreads
OpenMP

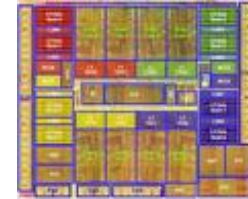

Sun
T2

CUDA
OpenCL

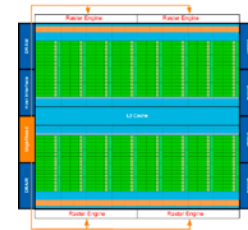

Nvidia
Fermi

Verilog
VHDL

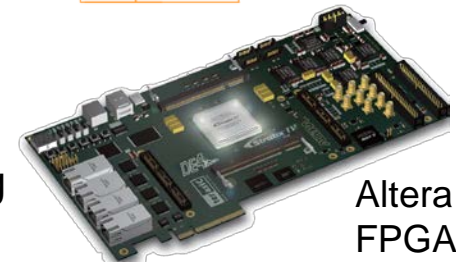

Altera
FPGA

MPI

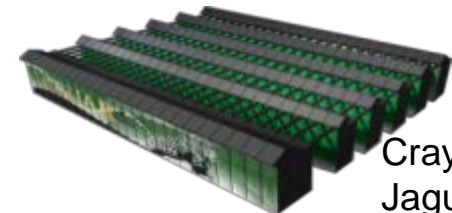

Cray
Jaguar

Programmability Chasm

Applications

Scientific
Engineering

Virtual
Worlds

Personal
Robotics

Data
informatics



Pthreads
OpenMP

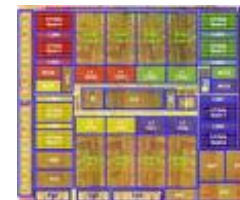

Sun
T2

CUDA
OpenCL

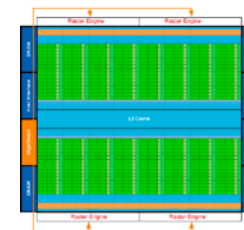

Nvidia
Fermi

Verilog
VHDL

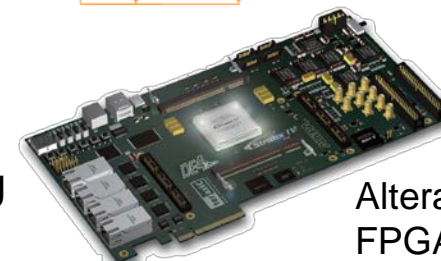

Altera
FPGA

MPI

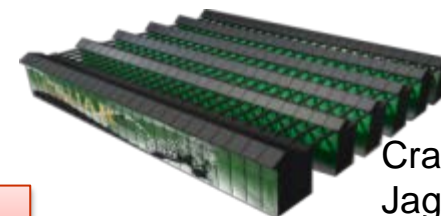

Cray
Jaguar

Too many different programming models

**IS IT POSSIBLE TO WRITE
ONE PROGRAM
AND
RUN IT ON ALL THESE TARGETS?**

Programmability Chasm

Applications

Scientific
Engineering

Virtual
Worlds

Personal
Robotics

Data
informatics



Ideal Parallel
Programming Language



Pthreads
OpenMP

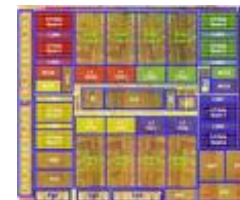

Sun
T2

CUDA
OpenCL

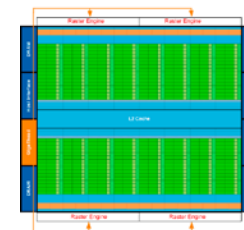

Nvidia
Fermi

Verilog
VHDL

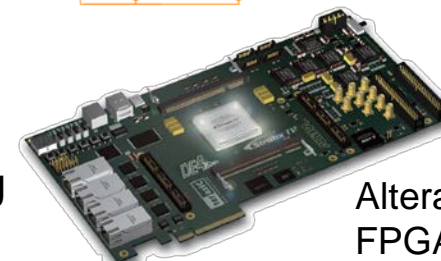

Altera
FPGA

MPI

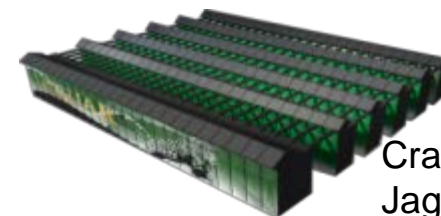

Cray
Jaguar

The Ideal Parallel Programming Language

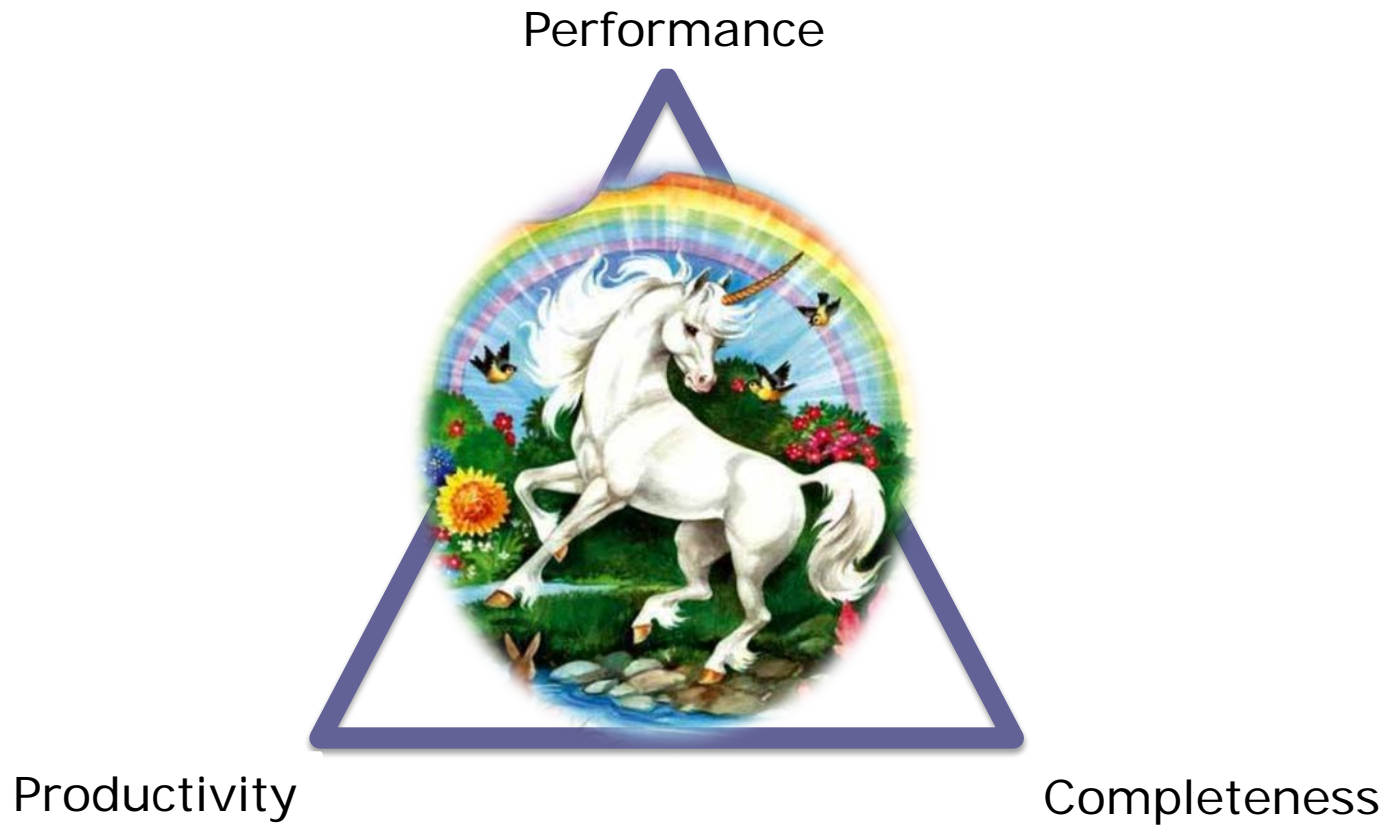

Successful Languages

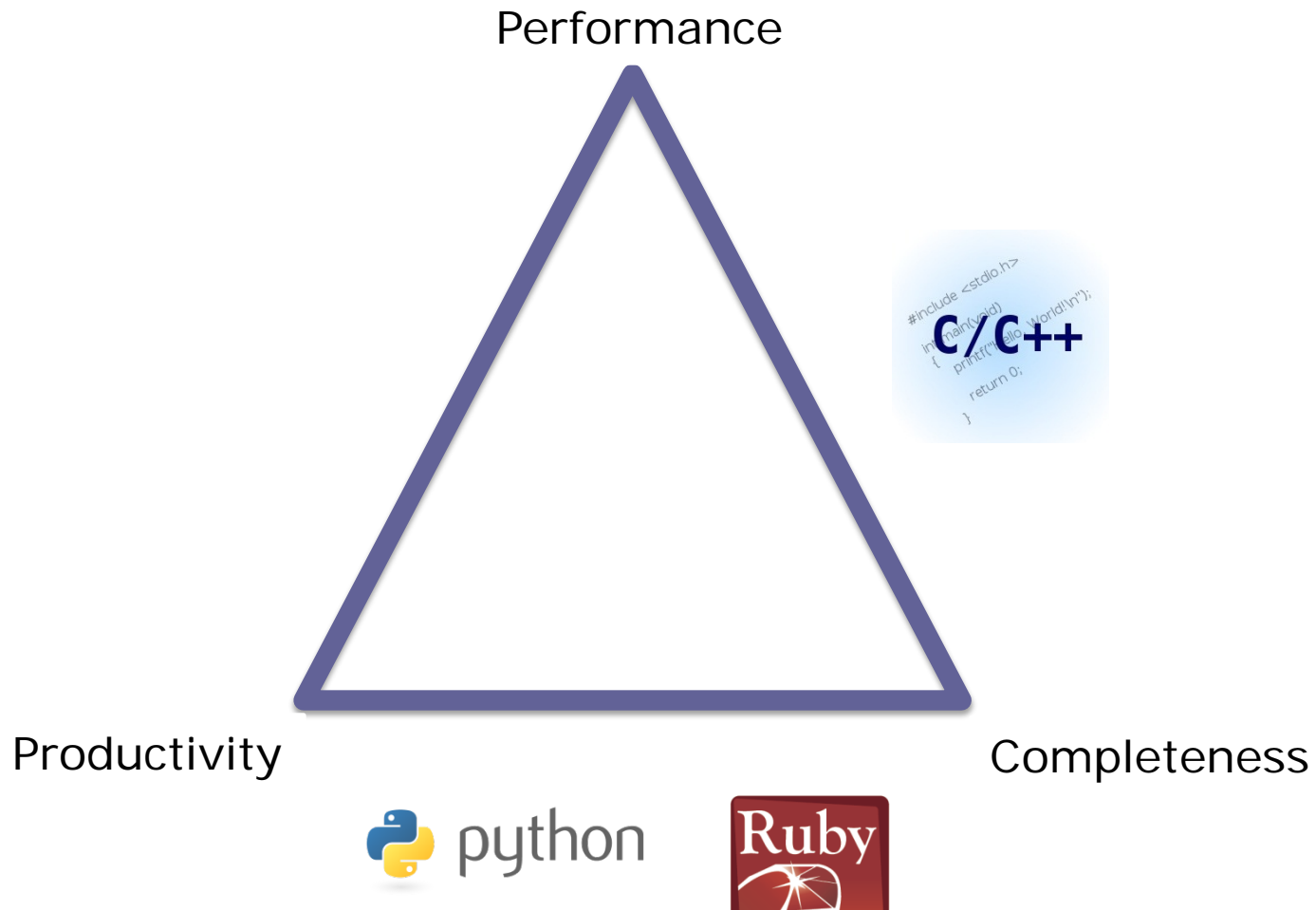

Successful Languages

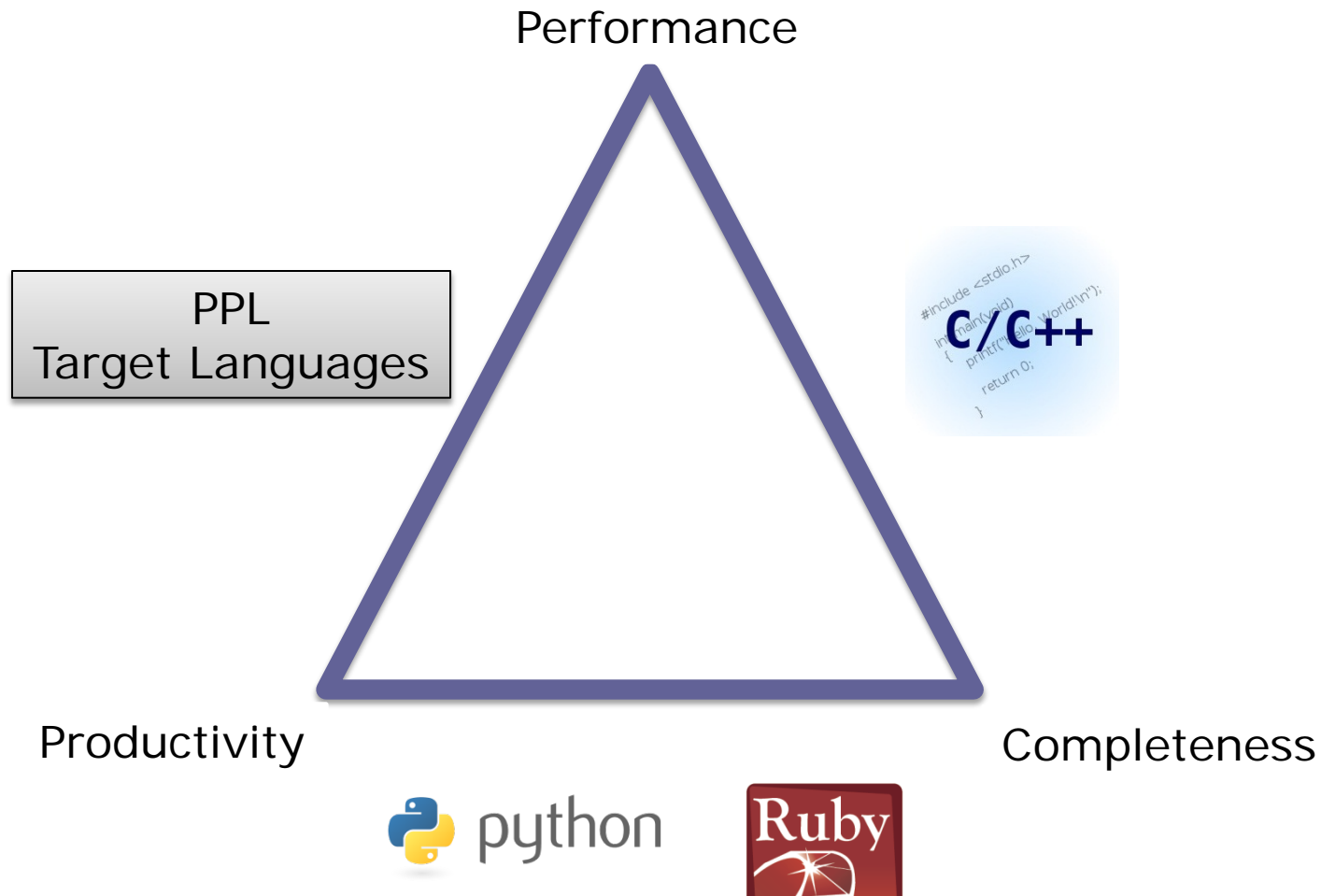

Domain Specific Languages

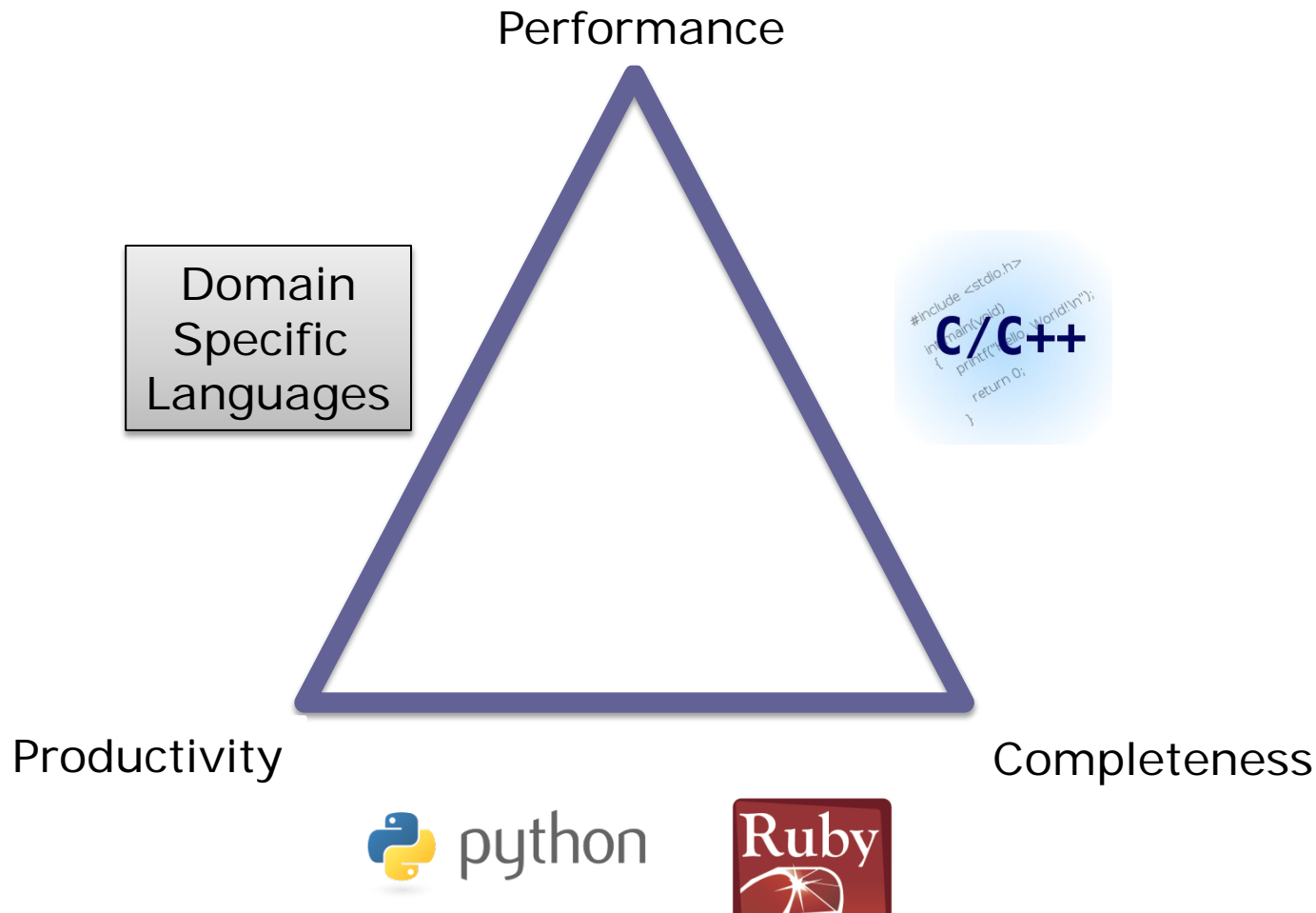

**IS IT POSSIBLE TO WRITE
ONE PROGRAM
AND
RUN IT ON ALL THESE TARGETS?**

HYPOTHESIS: YES, BUT NEED

DOMAIN-SPECIFIC

LIBRARIES AND LANGUAGES

A Solution For Pervasive Parallelism

- Domain Specific Languages (DSLs)
 - Programming language with restricted expressiveness for a particular domain



Benefits of Using DSLs for Parallelism



Productivity

- Shield average programmers from the difficulty of parallel programming
- Focus on developing algorithms and applications and not on low level implementation details



Performance

- Match generic parallel execution patterns to high level domain abstraction
- Restrict expressiveness to more easily and fully extract available parallelism
- Use domain knowledge for static/dynamic optimizations

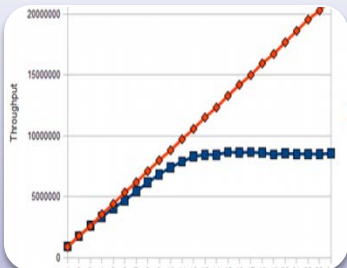

Portability and forward scalability

- DSL & Runtime can be evolved to take advantage of latest hardware features
- Applications remain unchanged
- Allows HW vendors to innovate without worrying about application portability

Bridging the Programmability Chasm

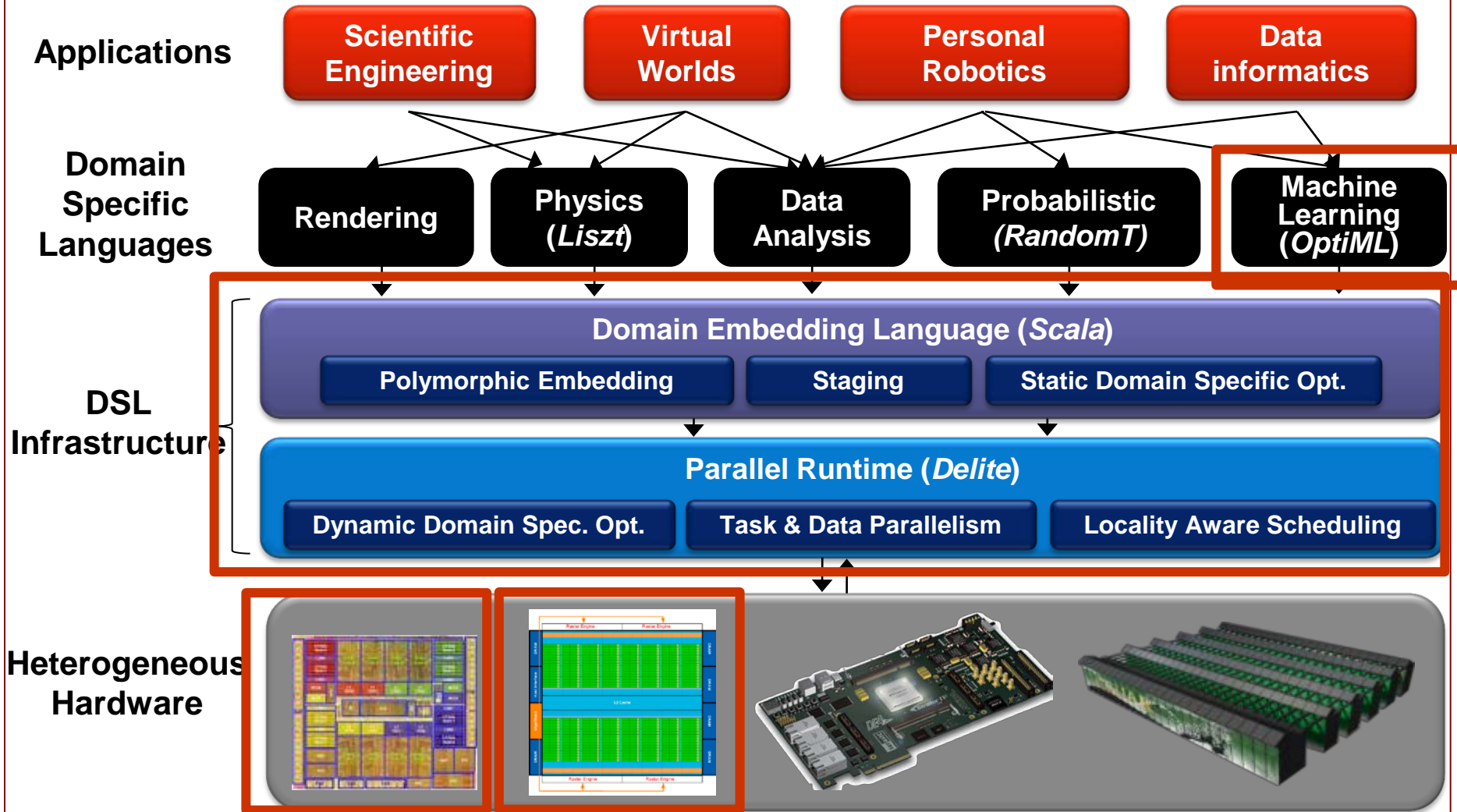

OptiML: A DSL for ML

- Machine Learning domain
 - Learning patterns from data
 - Applying the learned models to tasks
 - Regression, classification, clustering, estimation
 - Computationally expensive
 - Regular and irregular parallelism



- Characteristics of ML applications
 - Iterative algorithms on fixed structures
 - Large datasets with potential redundancy
 - Trade off between accuracy for performance
 - Large amount of data parallelism with varying granularity
 - Low arithmetic intensity

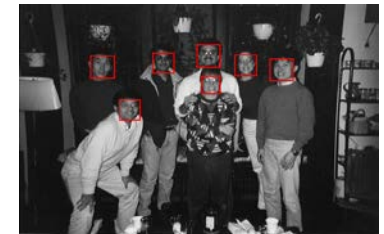

OptiML: Motivation

- Raise the level of abstraction
 - Focus on algorithmic description, get parallel performance
- Use domain knowledge to identify coarse-grained parallelism
 - Identify parallel and sequential operations in the domain (e.g. 'summations, batch gradient descent')
- Single source => Multiple heterogeneous targets
 - Not possible with today's MATLAB support
- Domain specific optimizations
 - Optimize data layout and operations using domain-specific semantics
- A driving example
 - Flesh out issues with the common framework, embedding etc.

OptiML: Overview

- Provides a familiar (MATLAB-like) language and API for writing ML applications
 - Ex. `val c = a * b` (`a, b` are `Matrix[Double]`)
- Implicitly parallel data structures
 - General data types : `Vector[T]`, `Matrix[T]`
 - Special data types : `TrainingSet`, `TestSet`, `IndexVector`, `Image`, `Video` ..
 - Encode semantic information
- Implicitly parallel control structures
 - `sum{...}`, `(0::end) {...}`, `gradient { ... }`, `untilconverged { ... }`
 - Allow anonymous functions with restricted semantics to be passed as arguments of the control structures

Example OptiML / MATLAB code (Gaussian Discriminant Analysis)

ML-specific data types

```
// x : TrainingSet[Double]
// mu0, mu1 : Vector[Double]

val sigma = sum(0,x.numSamples) {
  if (x.labels(_)== false) {
    (x(_)-mu0).trans.outer(x(_)-mu0)
  }
  else {
    (x(_)-mu1).trans.outer(x(_)-mu1)
  }
}
```

Implicitly parallel control structures

Restricted index semantics

OptiML code

```
% x : Matrix, y: Vector
% mu0, mu1: Vector

n = size(x,2);
sigma = zeros(n,n);

parfor i=1:length(y)
  if (y(i) == 0)
    sigma = sigma + (x(i,:)-mu0)'*(x(i,:)-mu0);
  else
    sigma = sigma + (x(i,:)-mu1)'*(x(i,:)-mu1);
  end
end
```

(parallel) MATLAB code

MATLAB implementation

- `parfor` is nice, but not always best
 - MATLAB uses heavy-weight MPI processes under the hood
 - Precludes vectorization, a common practice for best performance
 - GPU code requires different constructs
- The application developer must choose an implementation, and these details are all over the code

```
ind = sort(randsample(1:size(data,2),length(min_dist)));
data_tmp = data(:,ind);
all_dist = zeros(length(ind),size(data,2));
parfor i=1:size(data,2)
    all_dist(:,i) =
sum(abs(repmat(data(:,i),1,size(data_tmp,2)) -
data_tmp),1)';
end
all_dist(all_dist==0)=max(max(all_dist));
```

Domain Specific Optimizations

- Relaxed dependencies
 - Iterative algorithms with inter-loop dependencies prohibit task parallelism
 - Dependencies can be relaxed at the cost of a marginal loss in accuracy
- Best effort computations
 - Some computations can be dropped and still generate acceptable results
 - Provide data structures with “best effort” semantics, along with policies that can be chosen by DSL users

S. Chakradhar, A. Raghunathan, and J. Meng. **Best-effort parallel execution framework for recognition and mining applications**. IPDPS'09

Delite: a framework to help build parallel DSLs

- Building DSLs is hard
 - Building parallel DSLs is harder
 - For the DSL approach to parallelism to work, we need many DSLs
- Delite provides a common infrastructure that can be tailored to a DSL's needs
 - An interface for mapping domain operations to composable parallel patterns
 - Provides re-usable components: GPU manager, heterogeneous code generation, etc.

Composable parallel patterns

- Delite view of a DSL: a collection of data(DeliteDSLTypes) and operations (OPs)
- Delite supports OP APIs that express parallel execution patterns
 - DeliteOP_Map, DeliteOP_Zipwith, DeliteOP_Reduce, etc.
 - Planning to add more specialized ops
 - DSL author maps each DSL operation to one of the patterns (can be difficult)
- OPs record their dependencies (both mutable and immutable)

Example code for Delite OP

```
case class OP_+[A](val collA: Matrix[A],  
                  val collB: Matrix[A],  
                  val out: Matrix[A])
```

Dependencies

```
(implicit ops: ArithOps[A])  
extends DeliteOP_ZipWith2[A,A,Matrix]{
```

```
def func = (a,b) => ops.+(a,b)
```

Execution pattern

Interface for this pattern

Delite: a dynamic parallel runtime

- Executes a task graph on parallel, heterogeneous hardware
 - (paper) performs dynamic scheduling decisions
 - (soon) both static and dynamic scheduling
- Integrates task and data parallelism in a single environment
 - Task parallelism at the DSL operation granularity
 - Data parallelism by data decomposition of a single operation into multiple tasks
- Provides efficient implementations of the execution patterns

Delite Execution Flow

Application

```
def example(a: Matrix[Int],  
           b: Matrix[Int],  
           c: Matrix[Int],  
           d: Matrix[Int]) =  
{  
  
  val ab = a * b  
  val cd = c * d  
  return ab + cd  
}
```



**Calls Matrix
DSL methods**

Matrix DSL

```
def *(m: Matrix[Int]) =  
  delite.defer(OP_mult(this, m))  
  
def +(m: Matrix[Int]) =  
  delite.defer(OP_plus(this, m))
```

**DSL defers OP
execution to
Delite R.T.**

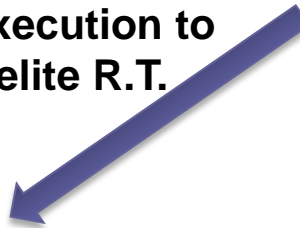

Delite Runtime

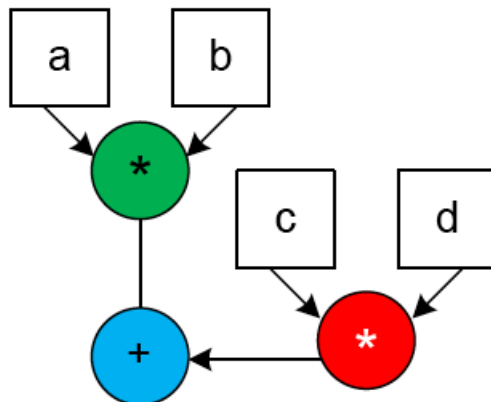

**Delite applies
generic & domain
transformations and
generates mapping**

Hardware Schedule

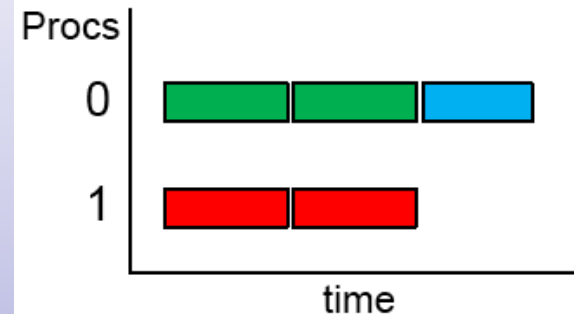

Using GPUs with MATLAB

■ MATLAB Parallel Computing Toolbox

```
sigma = gpuArray(zeros(n,n));
for i=1:m
    if (y(i) == 0)
        sigma = sigma + gpuArray(x(i,:)-mu0)'*gpuArray(x(i,:)-mu0);
    else
        sigma = sigma + gpuArray(x(i,:)-mu1)'*gpuArray(x(i,:)-mu1);
    end
end
```

■ AccelerEyes Jacket

```
sigma = gzeros(n,n);
y = gdouble(y);
x = gdouble(x);
for i=1:m
    if (y(i) == 0)
        sigma = sigma + (x(i,:)-mu0)'* (x(i,:)-mu0);
    else
        sigma = sigma + (x(i,:)-mu1)'* (x(i,:)-mu1);
    end
end
```

Using GPUs with Delite

- No change in the application source code
 - Same application code runs on any kind of heterogeneous system
 - Good for portability
 - Runtime (not the DSL user) dynamically determines whether to ship the operation to GPU or not
 - Good for productivity
- Performance optimizations under the hood
 - Memory transfer between CPU and GPU
 - On-chip device memory utilization
 - Concurrent kernel executions

Optimized GPU Runtime Diagram

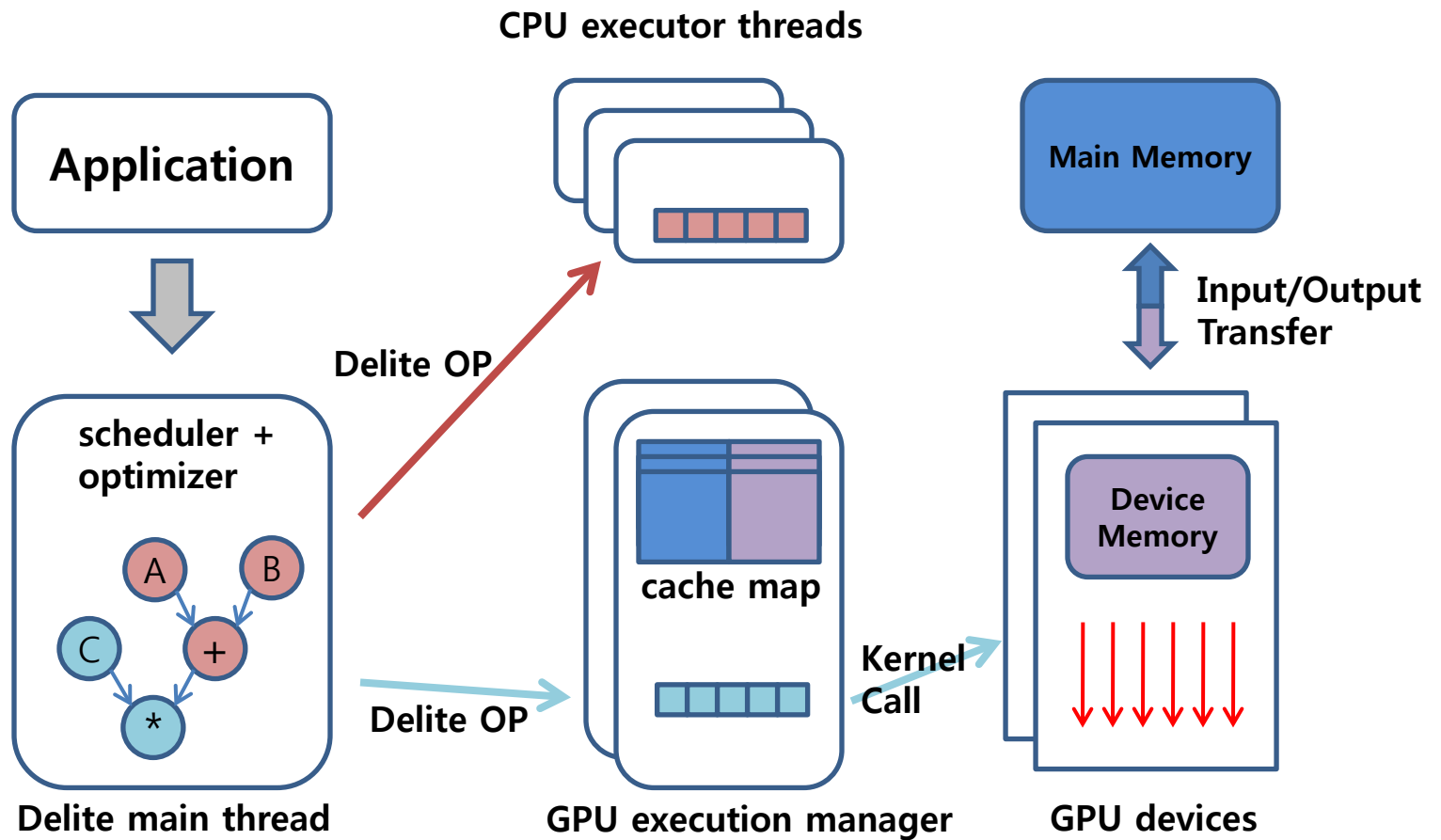

GPU Code generation

- DSL OPs require implementations of GPU kernels
 - (paper) DSL provides optimized implementations
 - Libraries (CUBLAS, CUFFT, etc) can be used
 - (now) GPU kernels generated from Scala kernels
 - Write once, run anywhere, libraries can still be used
- What about DSL constructs with anonymous functions?
 - The GPU task is given by DSL user, not DSL writer
 - Impossible to pre-generate kernels
 - Solution: Automatically generate corresponding GPU kernels at compile time

GPU Code Generation Flow

```
val a = Vector[Double](n)
val b = 3.28
val c = (0::n) { i => i * b * a(i) }
```

Original Code



Scala compiler plugin / embedding
(AST manipulation)

```
__global__ kernel0(double *input, double *output, int length, double *a, double b) {
  int i = blockIdx.x*blockDim.x + threadIdx.x;
  if(i < length)
    output[i] = input[i] * b * a[input[i]];
}
```

Generated CUDA Code



```
val a = Vector[Double](n)
val b = 3.28
val c = (0::n) { DeliteGPUFunc( {i => i * b * a(i)}, 0, List(a,b) ) }
```

Transformed Code

Experimental Setup

- 4 Different implementations
 - OptiML+Delite
 - MATLAB (Original, GPU, Jacket)
- System:
 - Intel Nehalem
 - 2 sockets, 8 cores, 16 threads
 - 24 GB DRAM
 - NVIDIA GTX 275 GPU

Benchmark Applications

- 6 machine learning applications
 - Gaussian Discriminant Analysis (GDA)
 - Generative learning algorithm for probability distribution
 - Loopy Belief Propagation (LBP)
 - Graph based inference algorithm
 - Naïve Bayes (NB)
 - Supervised learning algorithm for classification
 - K-means Clustering (K-means)
 - Unsupervised learning algorithm for clustering
 - Support Vector Machine (SVM)
 - Optimal margin classifier using SMO algorithm
 - Restricted Boltzmann Machine (RBM)
 - Stochastic recurrent neural network

Performance Study (CPU)

■ DELITE ■ Parallelized MATLAB

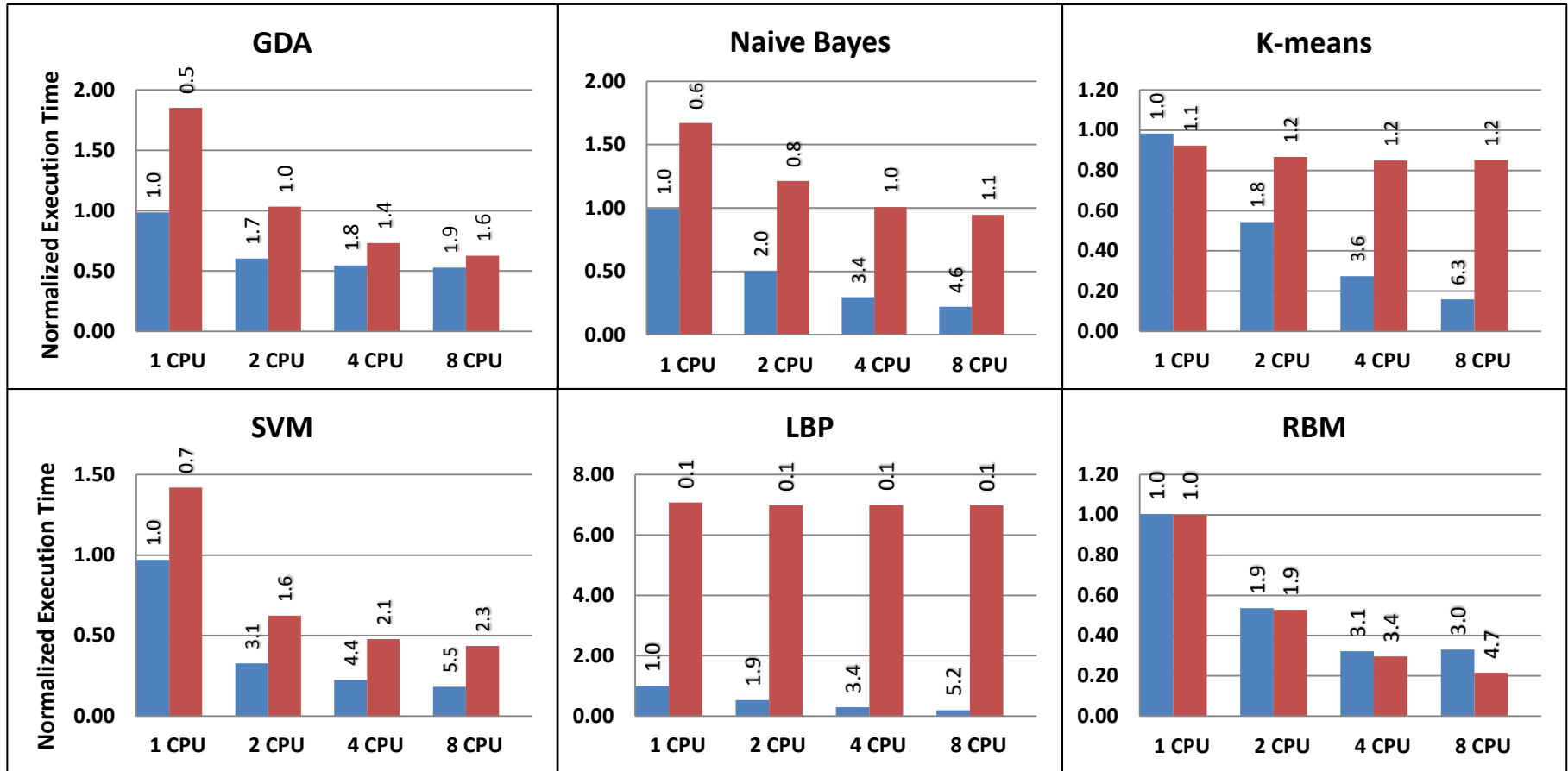

Performance Study (GPU)

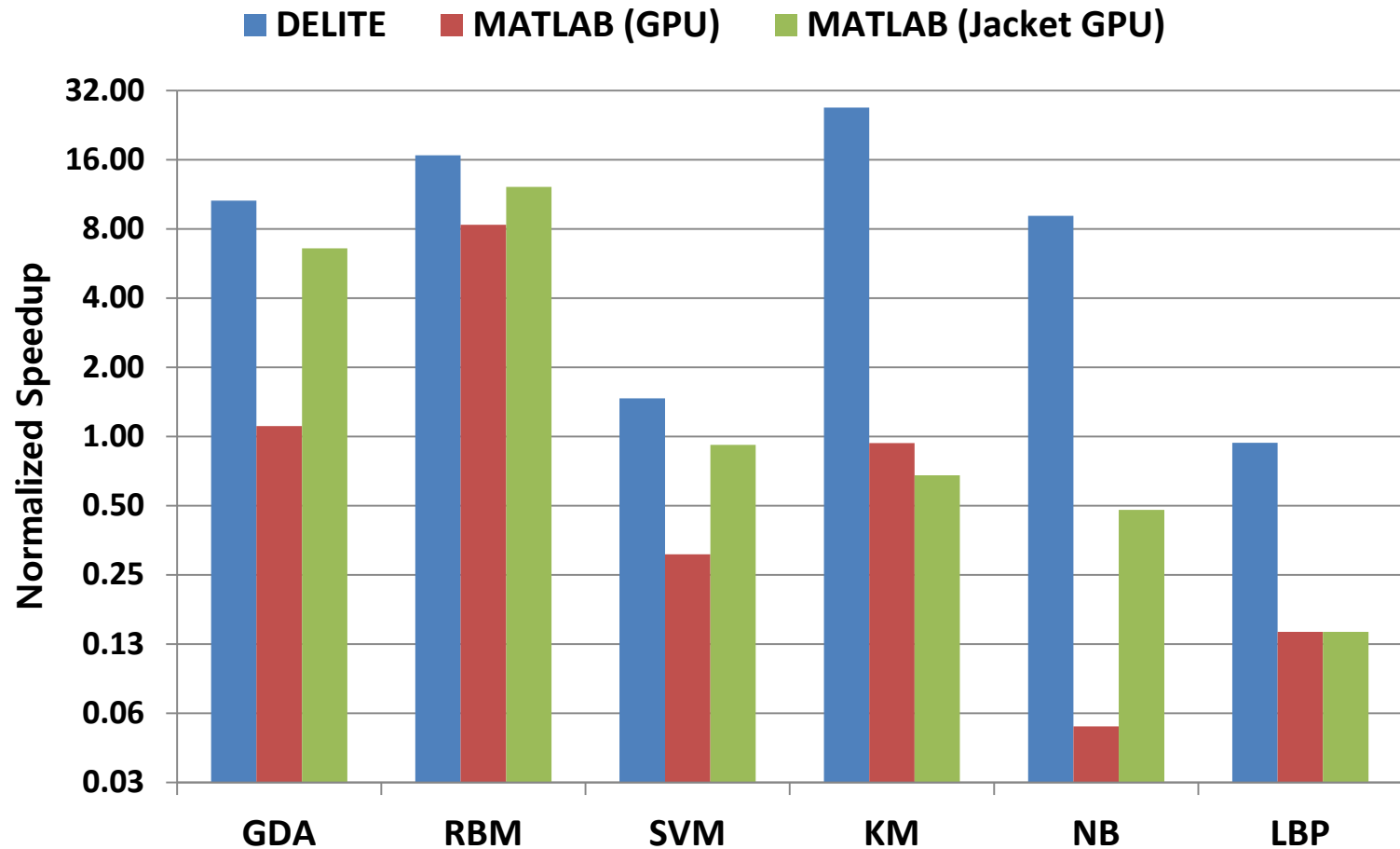

Speedup relative to single core execution time on Nehalem system

Domain Specific Optimizations

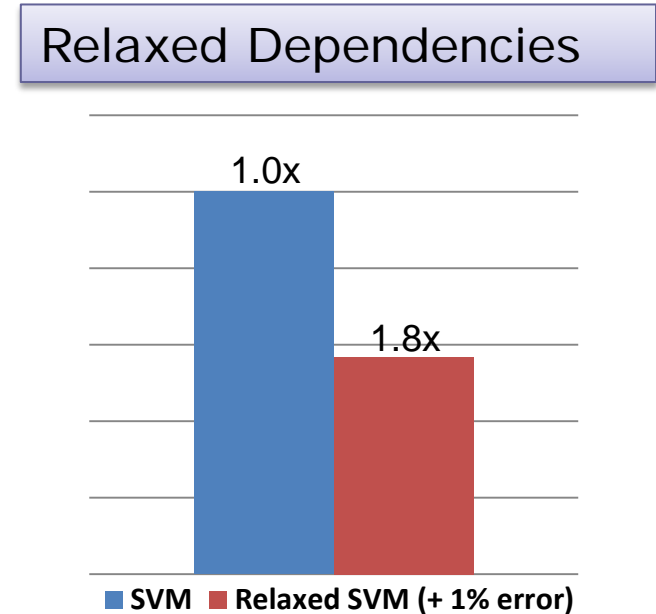
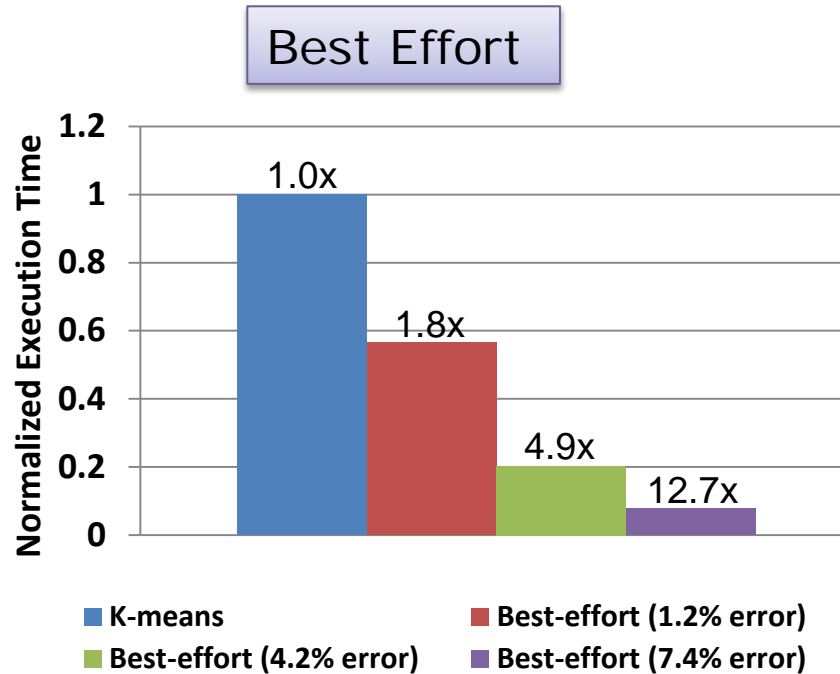

Speedup relative to 8 core execution time on Nehalem system

Conclusion

- Using Domain Specific Languages (DSLs) is a potential solution for heterogeneous parallelism
 - OptiML is a proof-of-concept DSL for ML
 - Productive, portable, performant
 - Delite is a framework for building DSLs and a parallel runtime
 - Simplifies developing implicitly parallel DSLs
 - Maps DSL to heterogeneous devices
 - Performs GPU specific optimizations and automatic code generation
 - Experimental results show that OptiML+Delite outperforms various MATLAB implementations